



Mapa Mental

Briseida Guadalupe Torres Zamorano.

Parcial II

Biología Molecular

Dr. Andrés Alonso Cancino García

Medicina Humana

4° "A"

Comitán de Domínguez, chis; A 11 de octubre de 2024.

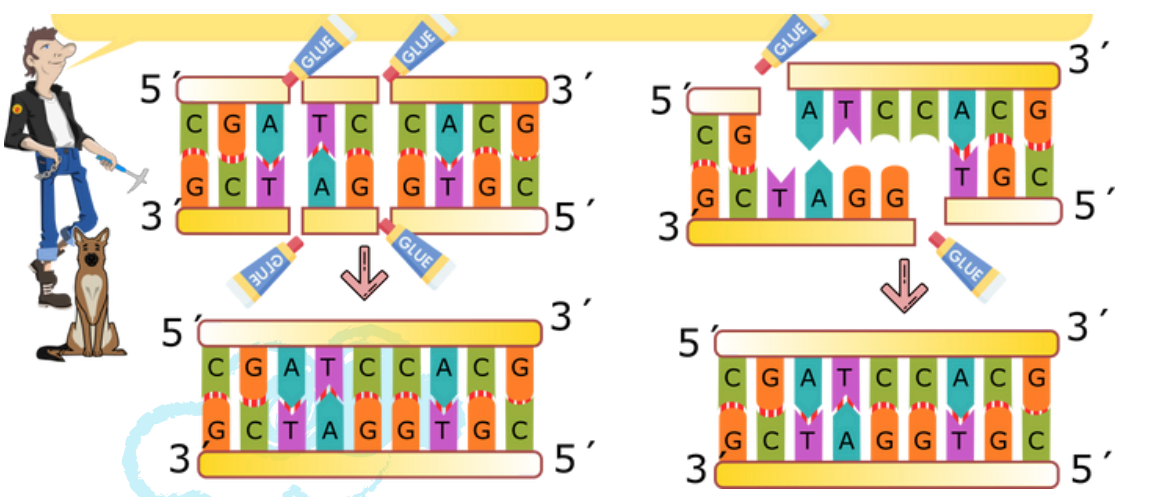
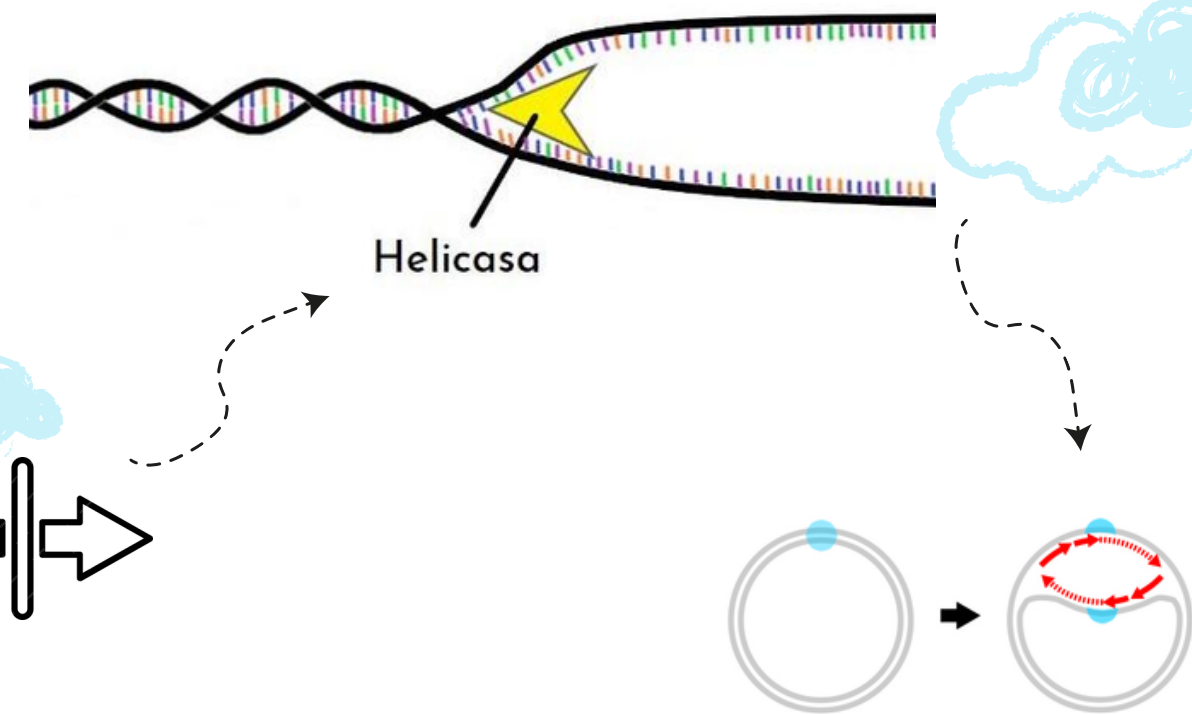
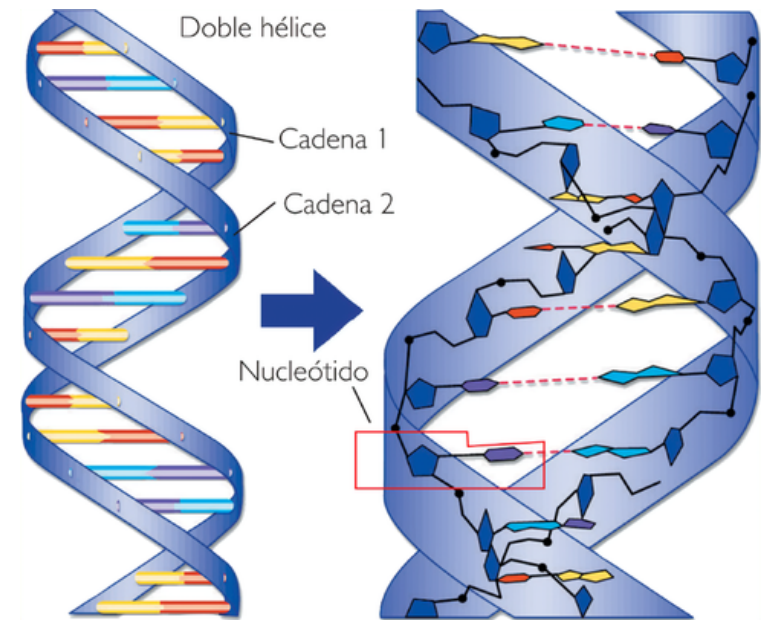
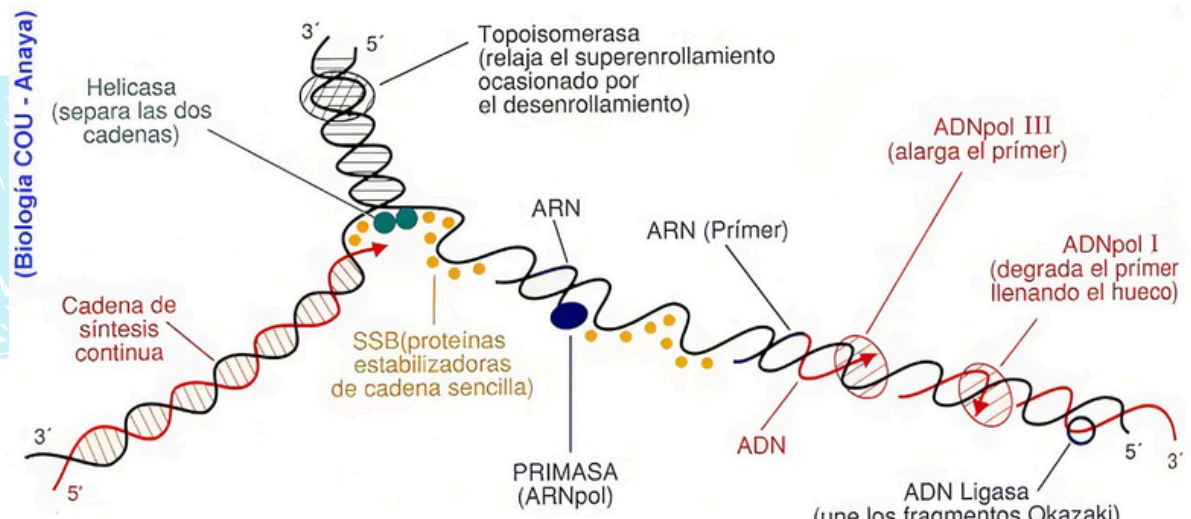

REPLICACIÓN DEL ADN

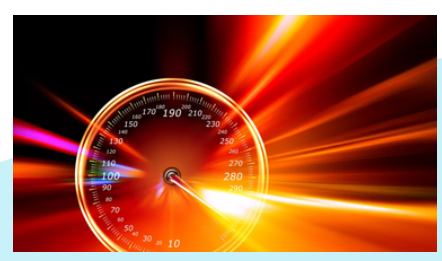
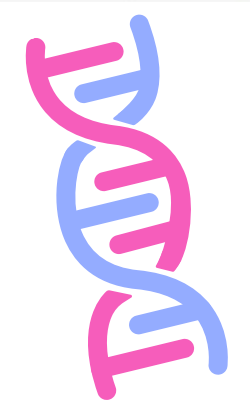
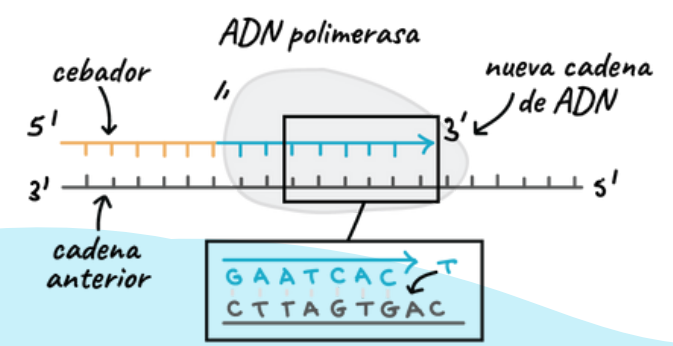
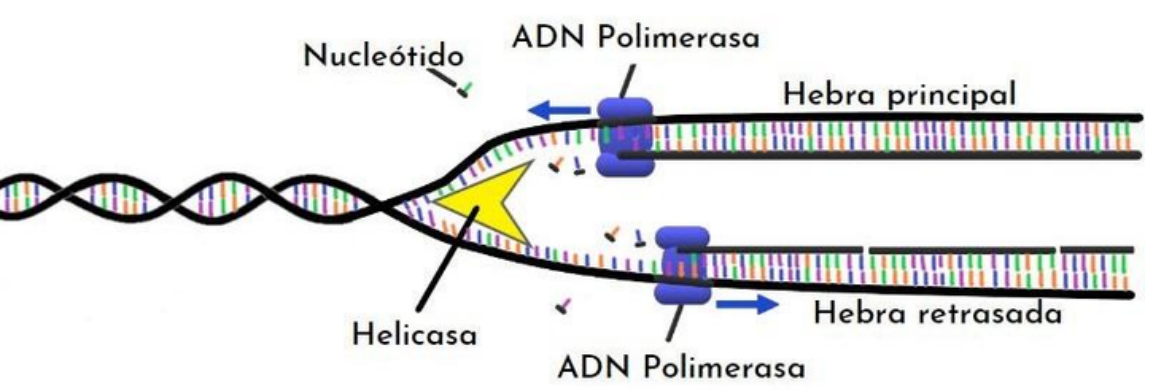
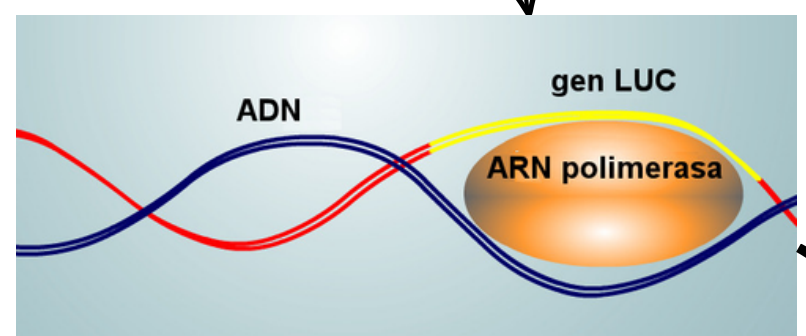
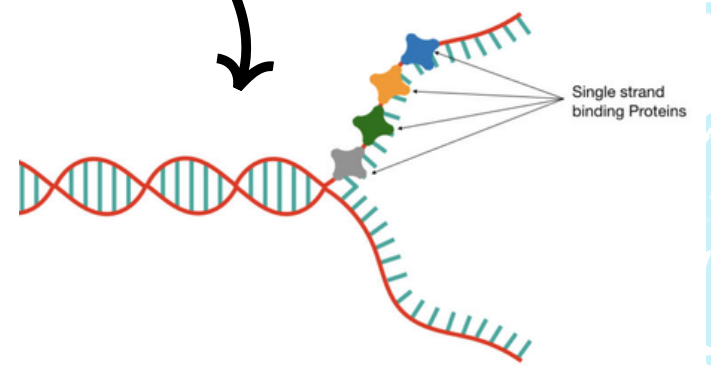
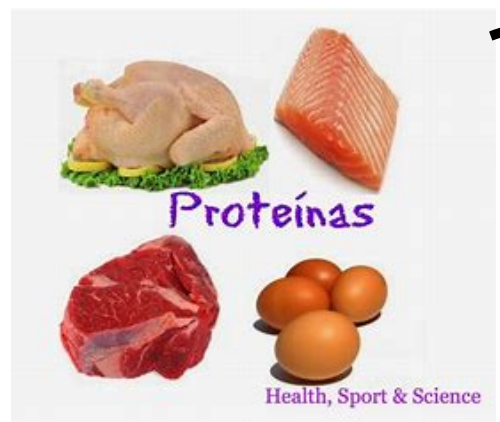

Bibliografía

- Biología molecular fundamentos y aplicaciones carlos beas, Daniel Ortuño 2009
- Lodish, H., *et al.* Molecular Cell Biology, 5th ed., W. H. Freeman, 2004.
[Biología celular y molecular (5ª ed.). Editorial médica panamericana, 2005