

**NOMBRE DEL ALUMNO:  
LUIS FERNANDO CALVO JIMÉNEZ.**

-

**NOMBRE DEL DOCENTE:  
VICTOR MANUEL GUILLEN SANTIAGO.**

-

**MATERIA:  
DISEÑO ARQUITECTÓNICO**

-

**ARQUITECTURA QUINTO CUATRIMESTRE**

-

**PLANOS.**

-

**17 DE MARZO DE 2021**

LOCALIZACIÓN

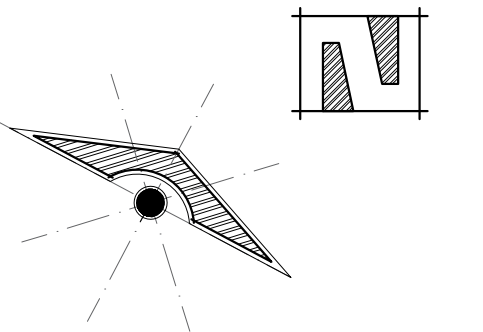

**SIMBOLOGÍA**

**SELLOS**

**DATOS DE LA OBRA**

SUPERFICIE DEL TERRENO: .....  
 SUPERFICIE CONSTRUIDA  
 PRIMER NIVEL: .....  
 SEGUNDO NIVEL: ..... M<sup>2</sup>  
 SEGUNDO NIVEL: ..... M<sup>2</sup>  
 SUPERFICIE TOTAL CONSTRUIDA:..... M<sup>2</sup>

**PROYECTO:**

CASA RESIDENCIAL

**DIRECCIÓN:**

**PROPIETARIO:**

PROYECTO

**NOMBRE DEL PLANO:**

PLANTA ARQUITECTÓNICA BAJA

**D.R.O.:**

ARO. LUIS FERNANDO CALVO JIMÉNEZ

**FIRMA:**

**ESCALA:**

1:100

**ACOTACIÓN:**

METROS

**PLANO:**

01/04

CLAVE

A-1

**FECHA:**

17/ MARZO / 2021

X

X'

K

K

Y

Y'

**PLANTA  
ARQUITECTÓNICA  
BAJA**

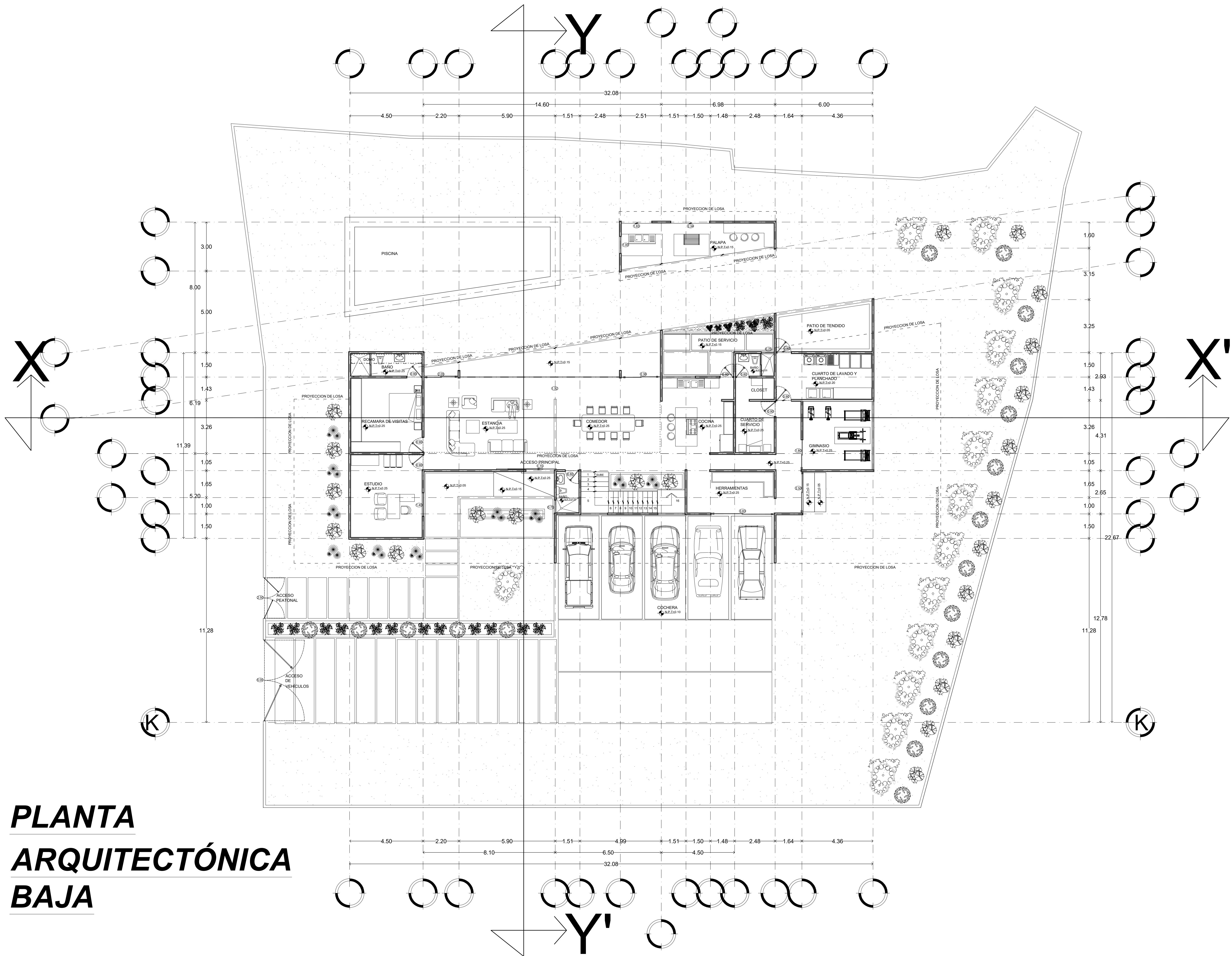

X

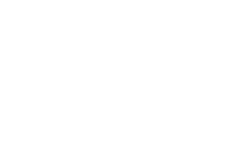
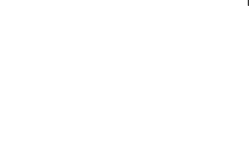
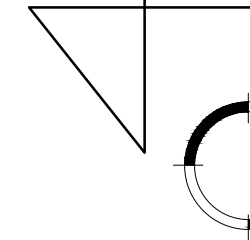

Y

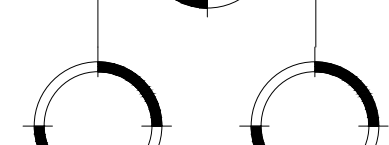
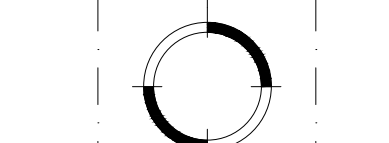
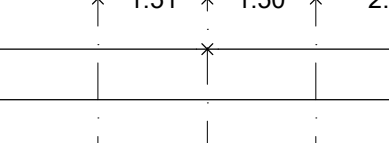
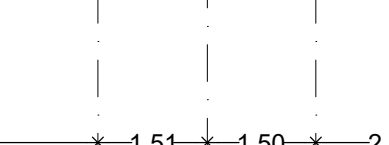
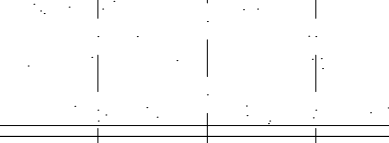
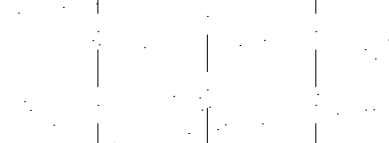
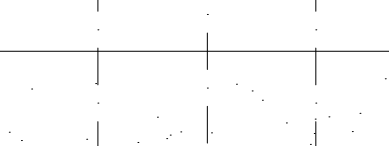
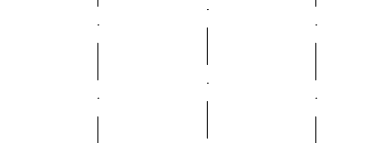
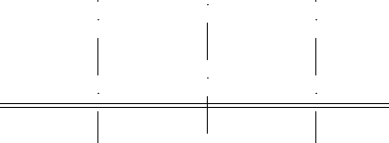
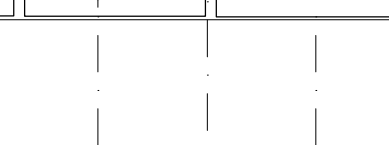
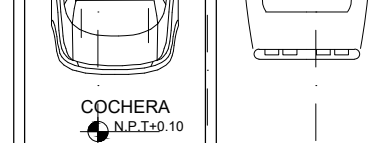
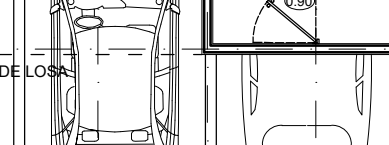
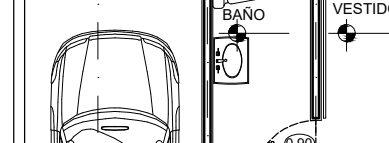
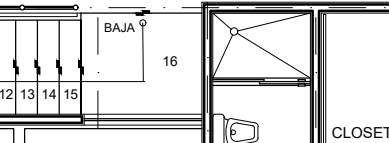
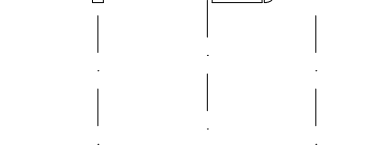
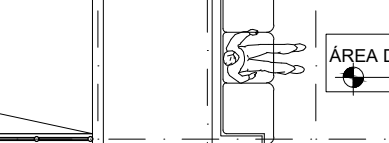
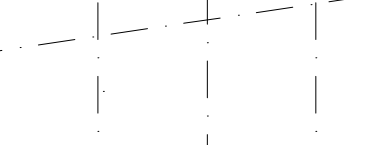
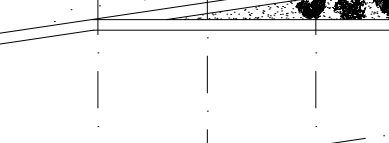
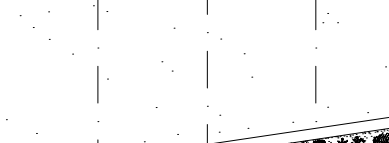
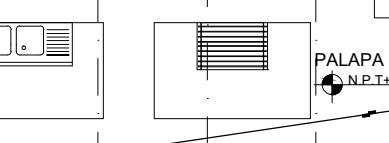
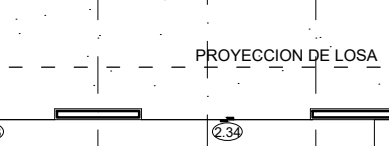
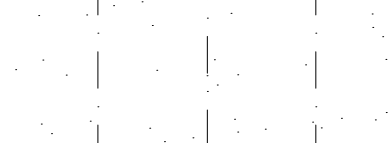
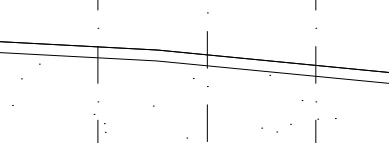
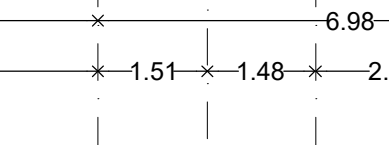
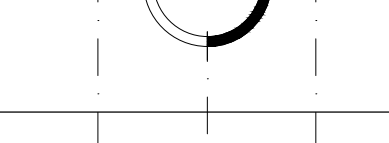
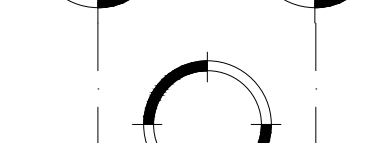
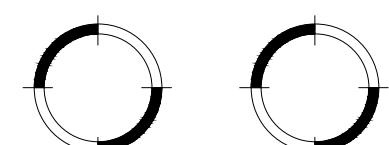

Y'



**PLANTA  
ARQUITECTÓNICA  
ALTA**



**UNIVERSIDAD  
DEL SURESTE**

LOCALIZACIÓN

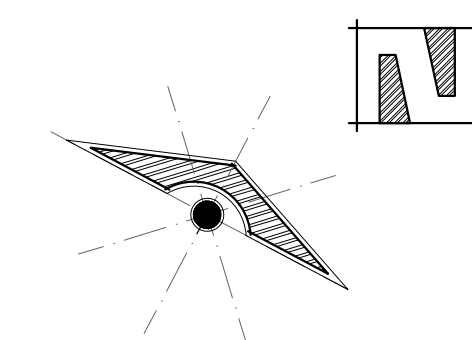

**SIMBOLOGÍA**

**SELLOS**

**DATOS DE LA OBRA**

SUPERFICIE DEL TERRENO: .....  
SUPERFICIE CONSTRUIDA  
PRIMER NIVEL: .....  
SEGUNDO NIVEL: ..... M<sup>2</sup>  
SEGUNDO NIVEL: ..... M<sup>2</sup>  
SUPERFICIE TOTAL CONSTRUIDA:..... M<sup>2</sup>

**PROYECTO:**

CASA RESIDENCIAL

**DIRECCIÓN:**

**PROPIETARIO:**

PROYECTO

**NOMBRE DEL PLANO:**

PLANTA ARQUITECTÓNICA ALTA

**D.R.O.:**

ARQ. LUIS FERNANDO CALVO JIMÉNEZ

**FIRMA:**

**ESCALA:**

1:100

**ACOTACIÓN:**

METROS

**PLANO:**

02 / 04

CLAVE

A-2

**FECHA:**

17 / MARZO / 2021

LOCALIZACIÓN

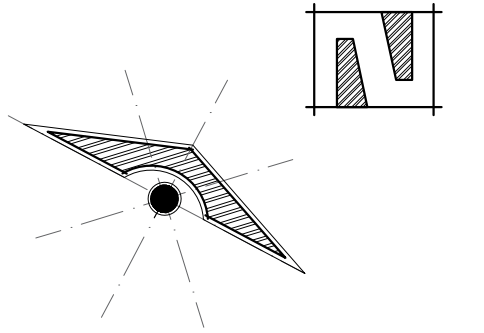

**SIMBOLOGÍA**

**SELLOS**

**DATOS DE LA OBRA**

SUPERFICIE DEL TERRENO: .....  
 SUPERFICIE CONSTRUIDA  
 PRIMER NIVEL: .....  
 SEGUNDO NIVEL: ..... M<sup>2</sup>  
 SEGUNDO NIVEL: ..... M<sup>2</sup>  
 SUPERFICIE TOTAL CONSTRUIDA:..... M<sup>2</sup>

**PROYECTO:**

CASA RESIDENCIAL

**DIRECCIÓN:**

**PROPIETARIO:**

PROYECTO

**NOMBRE DEL PLANO:**  
CORTES

**D.R.O.:**  
ARQ. LUIS FERNANDO CALVO JIMÉNEZ

**FIRMA:** **ESCALA:**  
1:100  
**ACOTACIÓN:**  
METROS

**PLANO:**  
03 / 04

CLAVE

A-3

**FECHA:**  
17 / MARZO / 2021

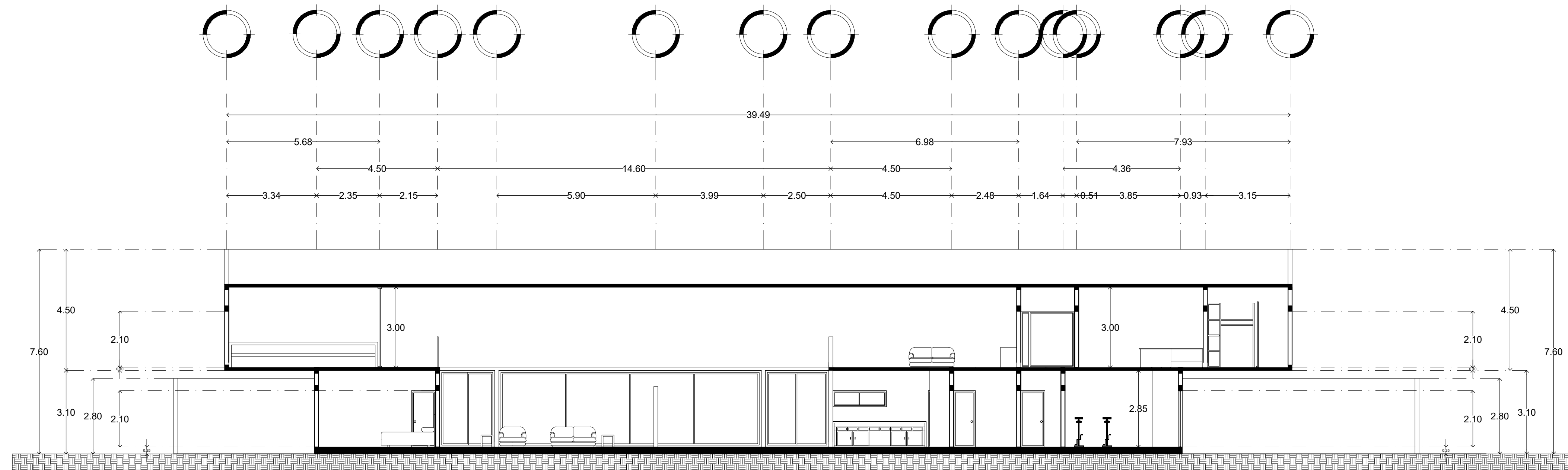

**CORTE LONGITUDINAL X - X'**

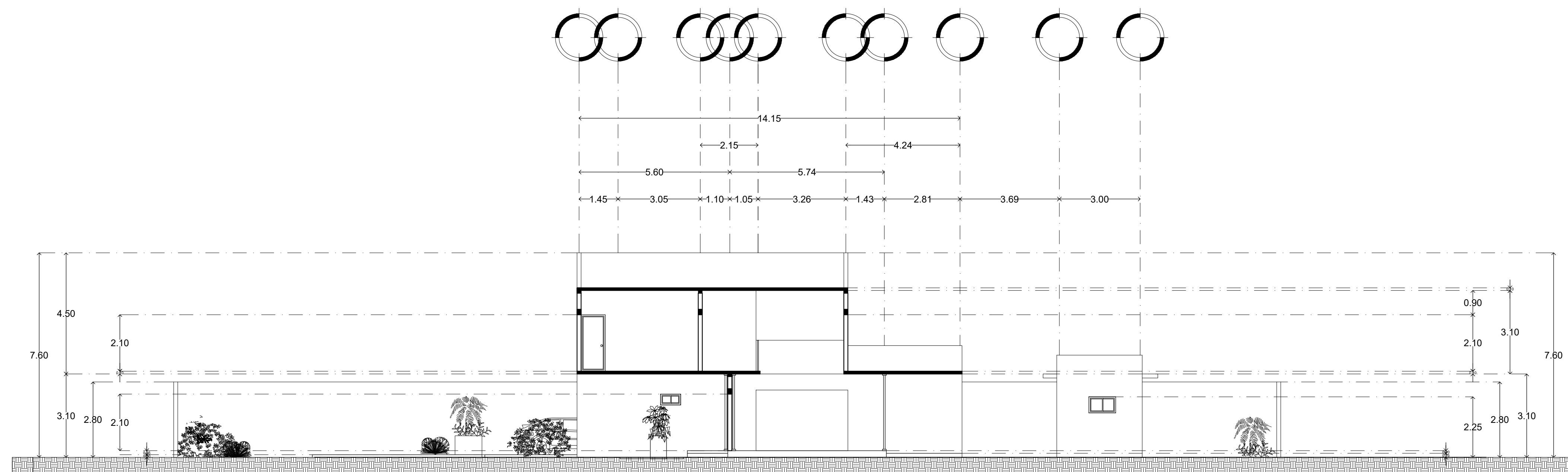

**CORTE TRANSVERSAL Y - Y'**

LOCALIZACIÓN

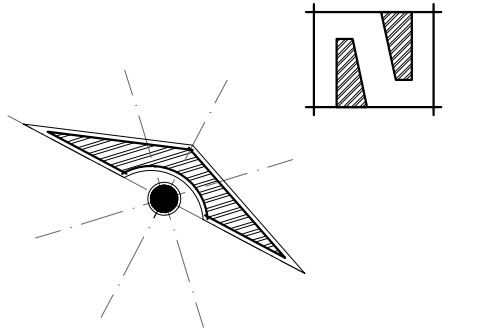

**SIMBOLOGÍA**

**SELLOS**

**DATOS DE LA OBRA**

SUPERFICIE DEL TERRENO: .....  
 SUPERFICIE CONSTRUIDA  
 PRIMER NIVEL: .....  
 SEGUNDO NIVEL: ..... M<sup>2</sup>  
 SEGUNDO NIVEL: ..... M<sup>2</sup>  
 SUPERFICIE TOTAL CONSTRUIDA:..... M<sup>2</sup>

**PROYECTO:**

CASA RESIDENCIAL

**DIRECCIÓN:**

**PROPIETARIO:**

PROYECTÓ

**NOMBRE DEL PLANO:**

VISTAS

**D.R.O.:**

ARQ. LUIS FERNANDO CALVO JIMÉNEZ

**FIRMA:**

**ESCALA:**

1:100

**ACOTACIÓN:**

METROS

**PLANO:**

04/04

CLAVE

A-4

**FECHA:**

17/ MARZO/ 2021

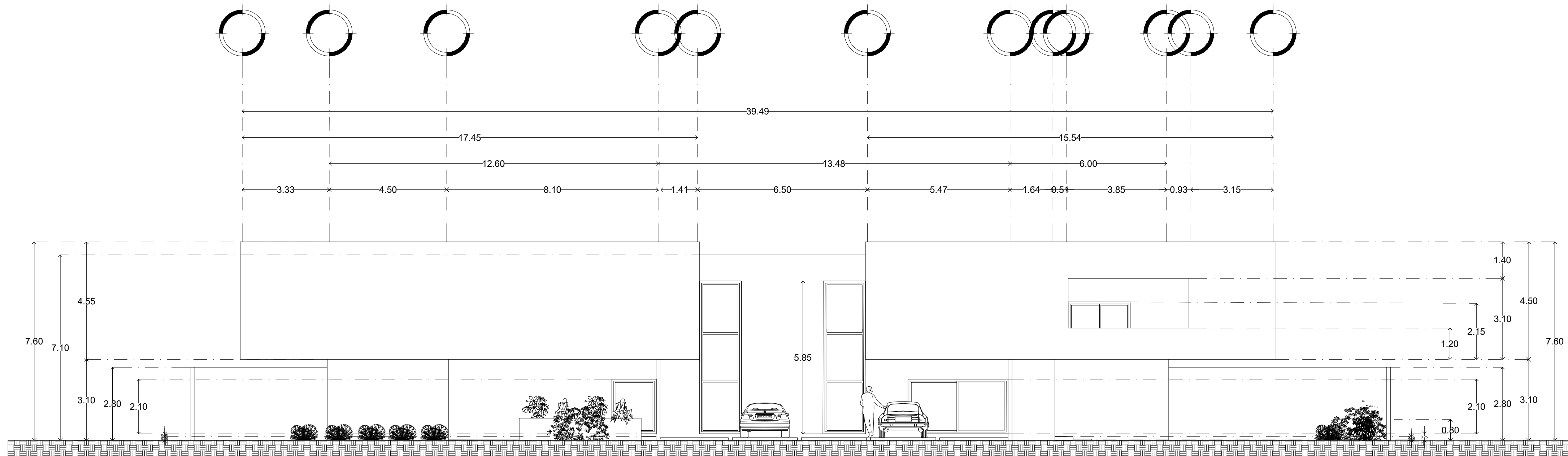

**FACHADA FRONTAL**

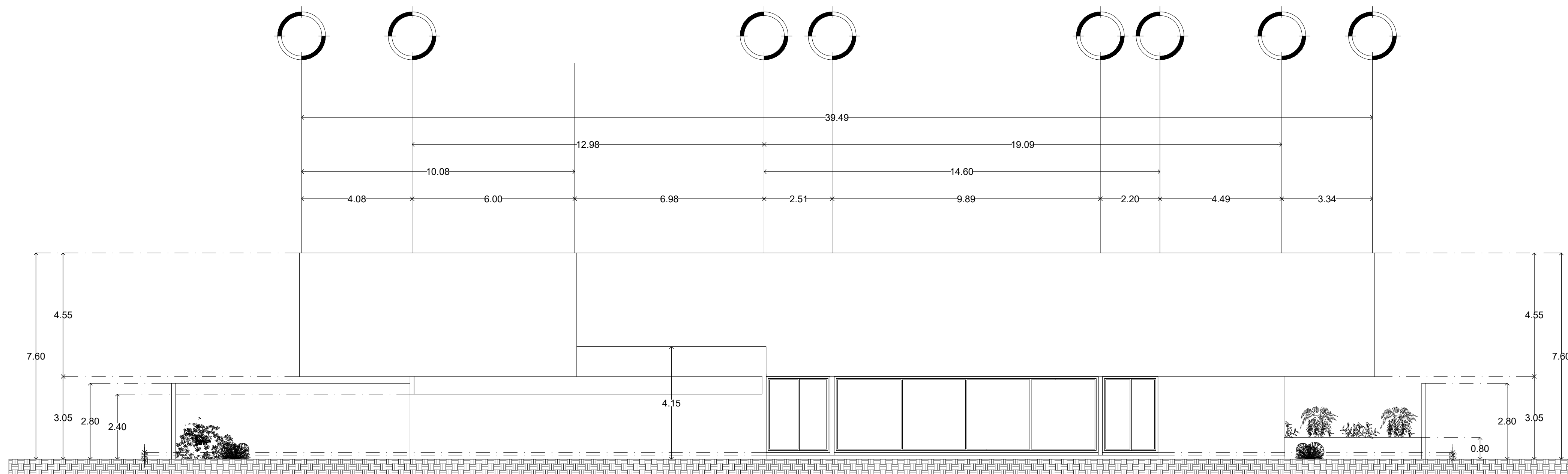

**FACHADA TRASERA**